

# MANSION HERRINGBONE DRYBACK

## INSTALLATION MANUAL

### IMPORTANT INFORMATION

Please contact the point of sale if you are unsure about any part of the installation and maintenance instructions or the warranty terms.

Solidfloor Dryback is a flexible PVC flooring that feels soft and warm underfoot. The floors are sound-absorbing and 100% water-resistant. Solidfloor Dryback is specially designed for fully glued installation to the subfloor using adhesive or with a self-adhesive underlay. Please take the following into account:

#### Installation with PVC adhesive

- ▶ If you choose to install it with adhesive, please ensure that the subfloor is professionally leveled. Refer to the paragraph on Subfloor for the applicable standards.
- ▶ For spaces larger than 150m<sup>2</sup> or longer than 25 m, expansion joints (at least 1 cm wide) should be used. Expansion joints can be neatly covered with expansion profiles.

#### Installation with self-adhesive underlay

- ▶ The self-adhesive underlay levels up to 1 mm.
- ▶ For spaces larger than 100m<sup>2</sup> or longer than 10 m, expansion joints (at least 1 cm wide) should be used. Expansion joints can be neatly covered with expansion profiles.

#### GENERAL REQUIREMENTS

- Tape
- Utility knife
- Ruler
- Optionally: Sealant (with caulking gun) + caulking supplies

#### INSTALLATION WITH ADHESIVE (page 3)

- Dryback adhesive
- Trowel
- Roller weighing at least 50kg (this can be rented if needed)

#### INSTALLATION WITH SELF-ADHESIVE UNDERLAY (page 4)

- Self-adhesive underlay
- Tape

#### General

- Allow the floor to acclimate in the packaging for a minimum of 48 hours in the room where it will be installed.
- During and after installation, maintain the room temperature between 18 and 27°C. The relative humidity should be between 40 and 65%.
- These floors are not suitable for outdoor installation or in areas that are consistently wet (saunas, swimming pools, and/or shower floors).
- There should be a minimum of 2.5 mm expansion gap around all walls or fixed elements (pillars, kitchen units, or baths) to allow for floor movement.
- Never install heavy, permanent, or structural elements such as kitchen islands or stairs on top of the floor.
- Check the floorboards for any defects or damage, as warranties only apply to hidden defects. If in doubt, contact the point of sale.

#### Subfloor

Proper preparation of the subfloor is essential for achieving the desired result. The subfloor should be hard, completely level, clean, structurally sound, free from cracks, and consistently dry (for concrete, maximum 2% moisture content). Additionally, the subfloor should be free from remnants of plaster, adhesive, paint, or other irregularities to prevent telegraphing. For concrete subfloors, they should be hard, completely level, and dry to prevent telegraphing. The subfloor should have a surface regularity that meets the SR1 standard (3 mm in 2 m reference BS8203).

#### Moisture in subfloors

If the residual moisture in the screed exceeds the prescribed values, regardless of whether the floors are old or new, a surface moisture barrier (SMB) should be installed. Always use a reliable construction moisture meter. The maximum allowable residual moisture is 2% for concrete screeds and 0.3% for calcium sulfate (anhydrite) screeds.

View the Solidfloor installation instruction video online at:



Instructions with adhesive.



Instructions with self-adhesive underlay.

## STURDY SUBFLOORS: CONCRETE / SAND-CEMENT SCREEDS

---

### New and old

For all concrete floors, mechanically sand the floor to remove contaminants (cement slurry, paint, plaster, adhesive, etc.), prime the floor, and then apply a compatible leveling compound with a minimum thickness of 3 mm. If a moisture barrier (DPM) needs to be installed, it should already be in place before applying the primer and leveling compound.

### Polished concrete floor

Polished concrete floors should be sanded before applying a layer of primer. Sanding can be done using milling or light sandblasting techniques. Floors should also be sanded when installing a moisture barrier (DPM). The sanding should be done before the moisture barrier (DPM) can be installed. Next, the floor should be primed before applying a compatible leveling compound (minimum 3 mm thick).

### 'Anhydrite' (calcium sulfate screed)

Anhydrite screeds can sometimes be difficult to recognize and may be mistaken for more traditional cement-based products. If the screed is not dry enough, consult the manufacturer and ensure that the appropriate leveling compound is selected.

### Painted Floors

Mechanically remove all paint back to the original base floor, prime the floor, and apply a compatible leveling compound with a minimum thickness of 3 mm.

### Stone Tile / Mosaic / Terrazzo / Ceramic

Check if the floor is free from signs of moisture (e.g., color variations, irregularities). Use a reliable moisture meter to exclude moisture. If moisture is detected after testing, consult your supplier. Inspect the floor surface for unstable, loose, and broken tiles. Remove loose particles and fill deep holes with quick-drying concrete. Degrease, rinse, and sand the surface of the floor. Apply a primer and a compatible leveling compound with a minimum thickness of 3 mm. A second layer of primer and leveling compound may be required to smooth out old tile grout lines.

## WOODEN SUBFLOORS: STANDARD

*(floorboards / Tongue and Groove / Chipboard / MDF / OSB)*

---

Floorboards should be securely fastened, loose planks should be tightly secured, and worn/damaged planks should be replaced. The floor should be leveled with plywood sheets or other suitable sheet materials. Screw or nail the plywood sheets to the subfloor with a maximum spacing of 150 mm. Joints should be smoothed with a filler or alternatively, a complete layer of fiber-reinforced leveling compound.

### Wavy Wooden Floors

These floors are not suitable for dryback floors.

## OTHER EXISTING SUBFLOORS:

### - RESILIENT FLOORS

*(e.g., linoleum, PVC, thermoplastic, carpet, cork, laminate)*

---

Remove existing floors and any traces of adhesive residues. Then treat the floor as prescribed in the previous chapter.

## FLOOR HEATING

---

The floor may only be installed on warm water underfloor heating. The surface temperature should not exceed 27°C. If this cannot be guaranteed, a two-component adhesive must be used for installation.

Note: If the underfloor heating is turned off after installation (or accidentally shuts off due to an automatic function or overnight), gaps and cracks may appear. Depending on the indoor climate, a dispersion adhesive will be fully cured within 72 hours. During this period, the thermoplastic-activated floor should not cool down, as the elements will contract linearly and remain permanently adhered in this smaller form.

For cooling systems, the system should have a condensation safeguard, ensuring that the water in the floor pipes does not differ by more than 3°C from the room temperature. This instruction applies only to warm water-based underfloor heating and underfloor heating with cooling, provided that a condensation safeguard is installed. Installation on electric underfloor heating is not allowed. PVC Dryback should not be installed on underfloor heating systems installed before 1990, as these systems generally produce higher temperatures.

If you have doubts about the subfloor, do not proceed with the installation and contact your point of sale for further advice. The final result heavily depends on the conditions under which the floorboards are installed.

# INSTALLATION WITH DRYBACK ADHESIVE

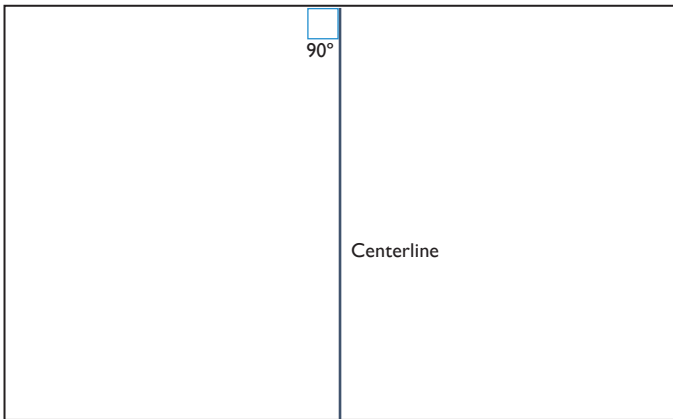

- 1 Determine (from the perspective of the starting wall) the center of the room. Use a chalk line to create a line perpendicular to the starting wall and pull it tightly. This is the centerline.

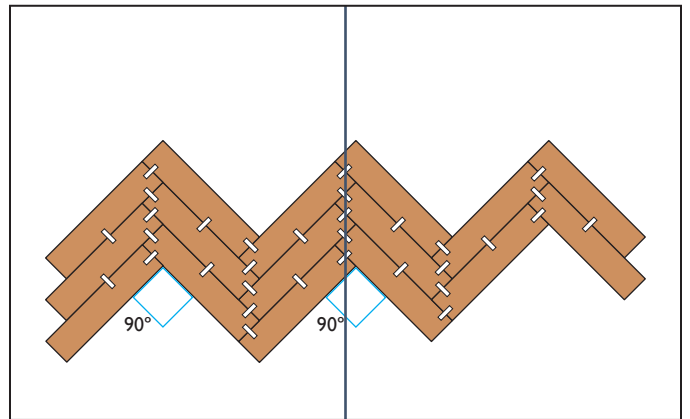

- 2 Lay two to three rows of strips next to each other. Ensure that the corners are perfectly 90° and secure the corners together with tape.

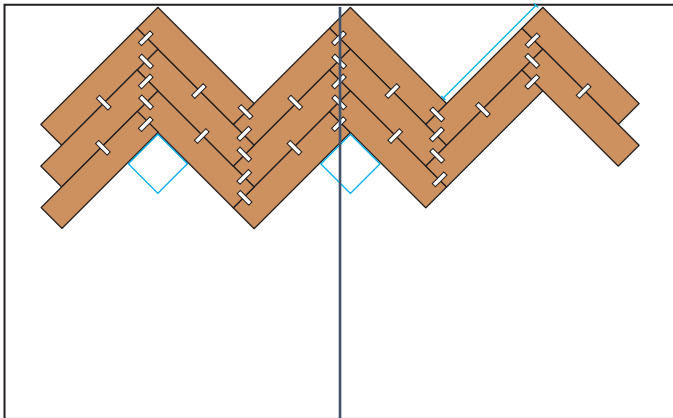

- 3 Place the attached strips against the starting wall, with the points aligned with the centerline as shown in the image next to it. Check if all the corners are 90° and if the distance to the starting wall is consistent throughout.

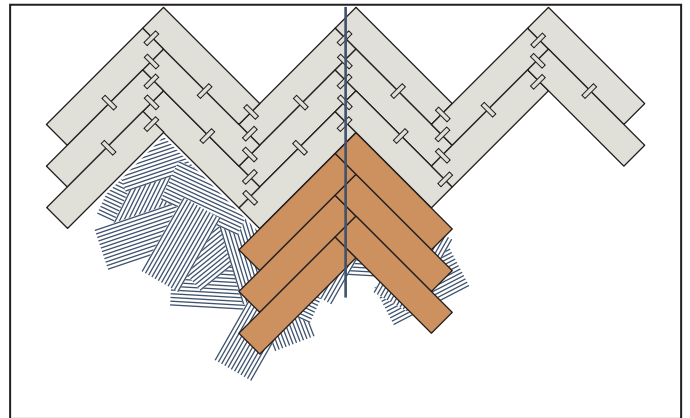

- 4 Follow the recommended guidelines for adhesive consumption, waiting time, and setting time. Use the notched trowel to spread the adhesive. Apply adhesive to the floor in a width that accommodates two or three strips (the dark strips in the image) and place these strips in the adhesive. The floorboards should be rolled immediately after laying the adhesive. Always do this within the specified working time of the adhesive.

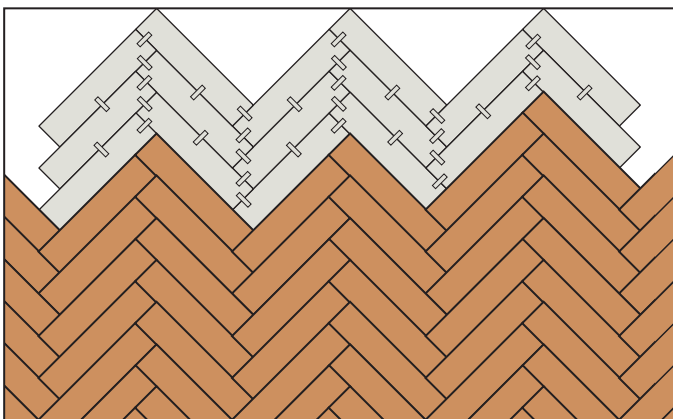

- 5 Repeat this procedure on the left and right sides of the laid starting strip. Continuously check if all the corners are still 90°.

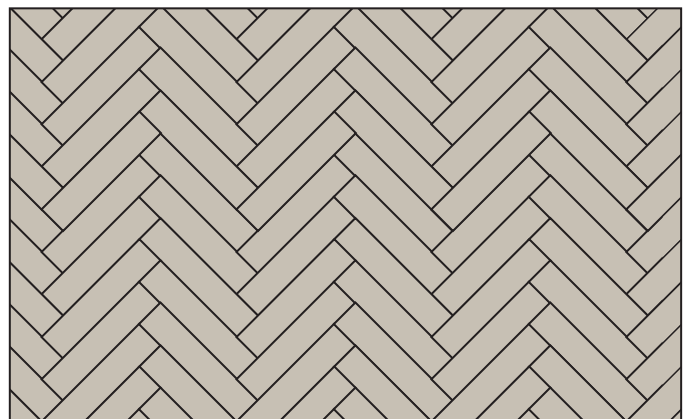

- 6 Remove the strips that were taped together and lay the floor close to the starting wall.

# INSTALLATION WITH SELF-ADHESIVE UNDERLAY (1)

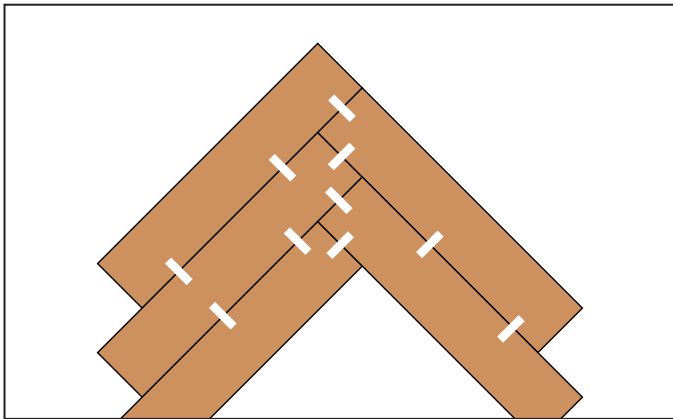

## 1 Creating the starter triangles

Align the pieces together as shown in the image above. Ensure that there is no gap or excess space between the planks. Secure these pieces together tightly with tape.

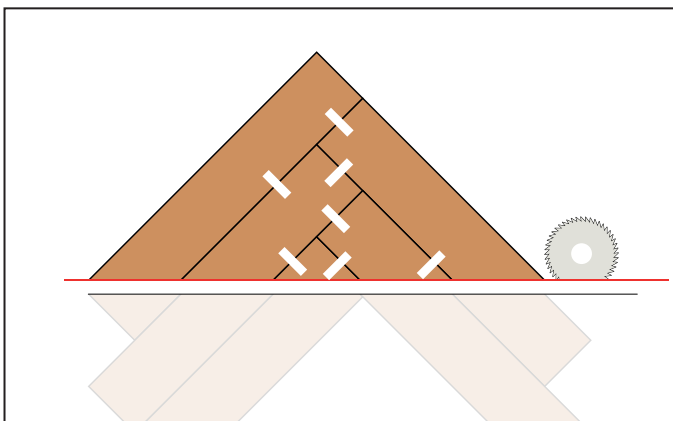

3 Cut the triangle along the red line as indicated in the image next to it. This is a starter triangle. The remaining planks below the red line can be used later for the final row. Ensure that all starter triangles are the same, with three planks on the left side of the triangle and two on the right side, as shown in the example above. Avoid having starter triangles with three planks on the right side and two on the left side.

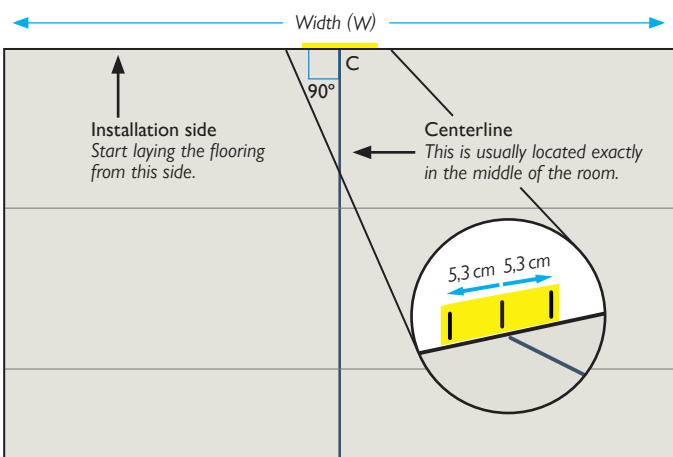

5 Mark the centerline with a marker along the entire length on the protective film of the self-adhesive underlay. Usually, this line is precisely in the middle of the room. Please note that this differs from the Installation Line (see step 8). The centerline should always be visible. Use a small piece of tape to mark the centerline on the wall, as shown by "C" in the image. Place two additional reference marks on both the left and right sides of "C" at a distance of 5.3 cm. You will need these when placing the first triangle.

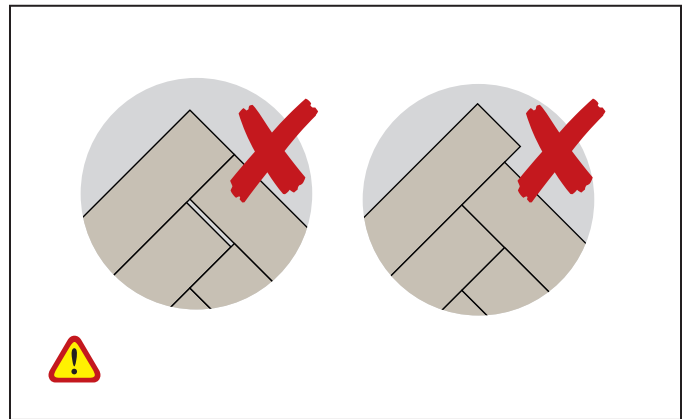

2 **Attention!** Installing a dryback floor requires some precision. The smallest allowable gap will repeat and become larger as the floor is further laid. Be meticulous about this for the best result.

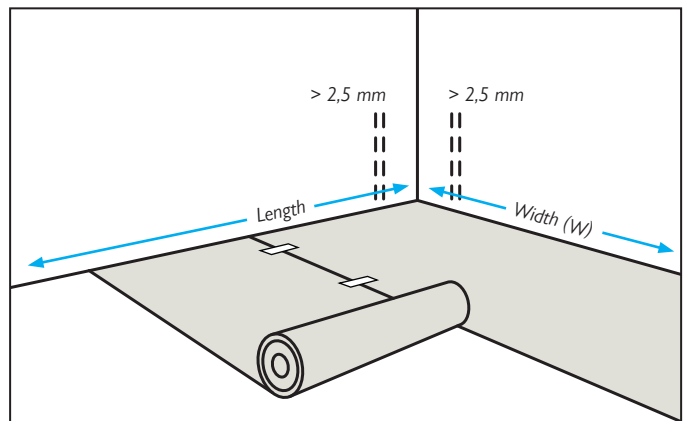

4 The self-adhesive underlay can be easily cut to size with a utility knife. Place the underlay along the width (W) of the room with the protective film facing up. Ensure that there is a 2.5 mm gap between the underlay and the wall. To prevent the underlay from shifting, secure the strips together with tape.

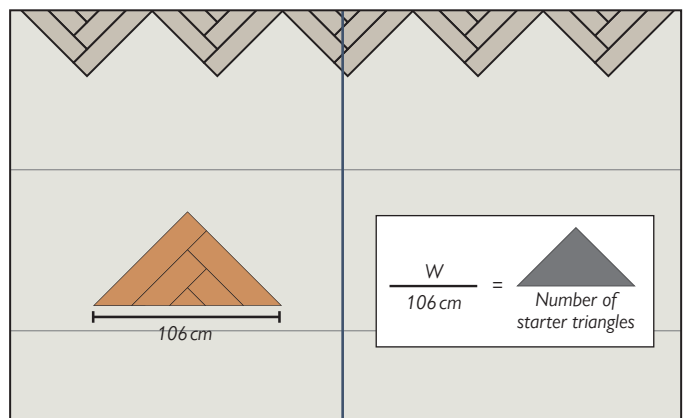

6 To determine the number of triangles needed, you will require the total width of the installation side. Divide this width by 106 cm (the longest side of the triangle).

# INSTALLATION WITH SELF-ADHESIVE UNDERLAYMENT (2)

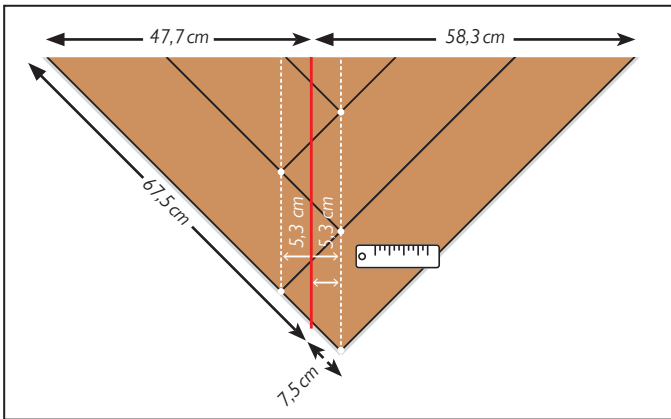

- 7 Installing the first row**  
 Determine the center of the herringbone pattern on the first triangle according to the illustration above. This is the installation line.  
 Note: the center is not the highest point of the triangle.

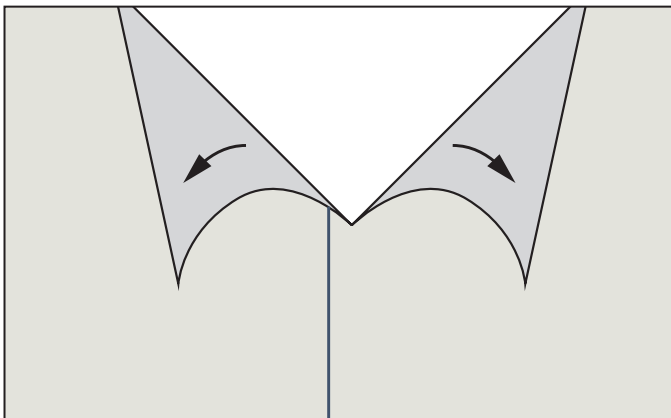

- 9** Place the first triangle on the self-adhesive underlayment so that the installation line aligns exactly with the centerline. To do this, gently peel back the protective film from the underlayment and make a small cut along the centerline.

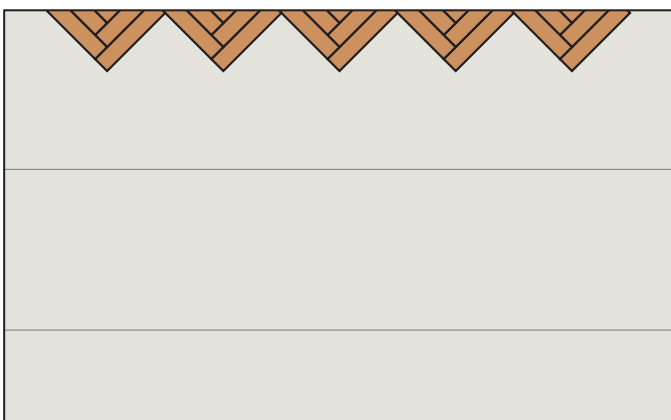

- 11** Also, secure the triangles on the left and right sides to the underlayment in the same way. By placing the protective film back over the triangles, the adhesive layer remains protected. Ensure that the exposed adhesive layer does not get contaminated, as this can reduce its adhesive quality. Avoid walking or kneeling on the exposed adhesive layer at all times.

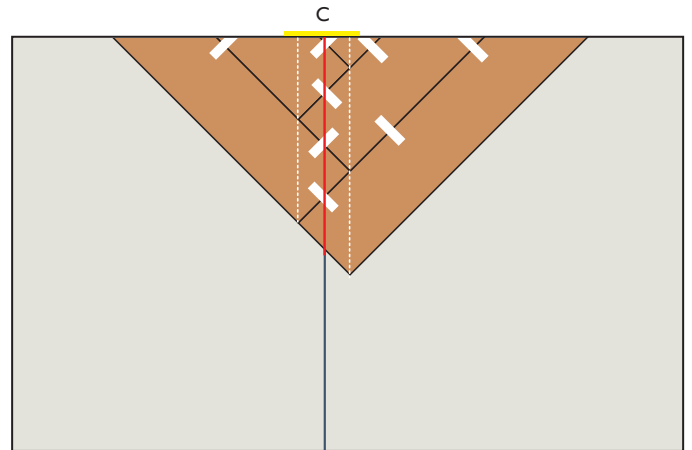

- 8** Place the first triangle in such a way that the installation line of the herringbone pattern aligns exactly with the centerline of the room. Use the marker (C) to verify this.

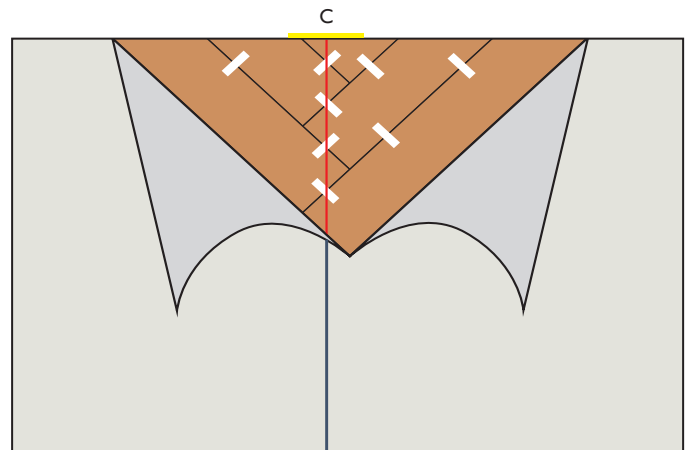

- 10** Peel back the protective film to the size of the starter triangle and place the first triangle on the self-adhesive underlayment.

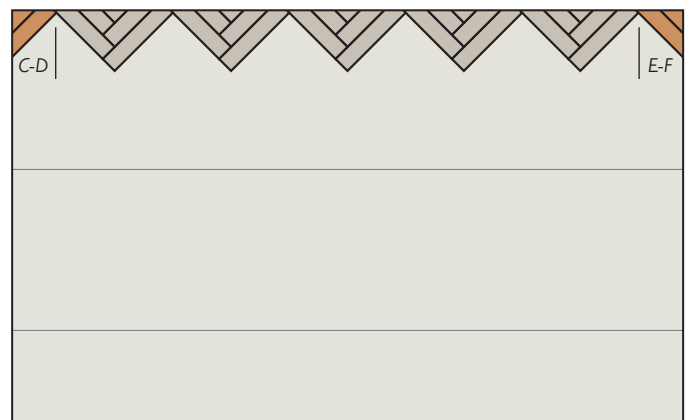

- 12** Fill in both sides. Cut distances C-D and E-F of the last triangle, and place it. The PVC Dryback pieces can be easily cut to size with a utility knife.

# INSTALLATION WITH SELF-ADHESIVE UNDERLAYMENT (3)

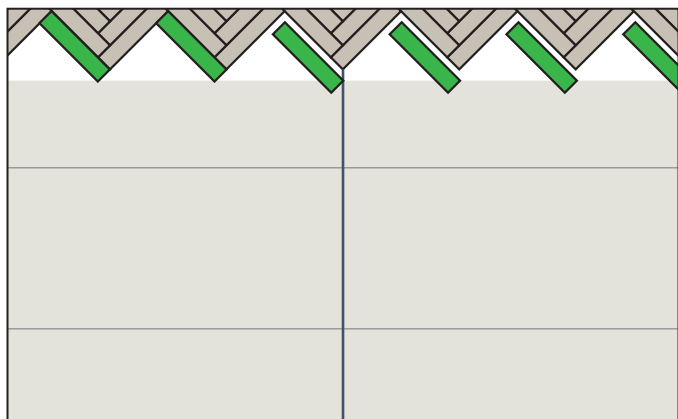

## 13 Laying the floor

Pull the foil slightly further from the subfloor and then place the planks successively on the self-adhesive underlay, one strip at a time. The first row of planks should be placed as straight as possible, with all strips tightly installed against each other. Deviations will disrupt the visual result of the floor throughout the entire space.

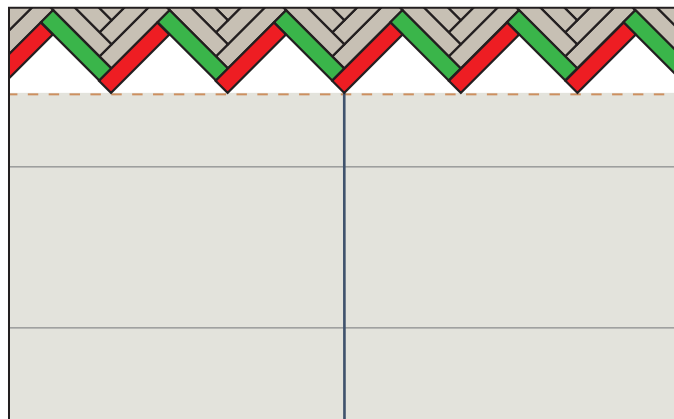

14 There is a maximum of 10 minutes to move incorrectly installed planks. However, do not do this too often (no more than 2 times), as it reduces the adhesive capability of the underlay. Do not load or put weight on the planks immediately after installation. The centerline should always be visible. Ensure that the straightness (the orange dotted line) remains straight in relation to the room at all times.

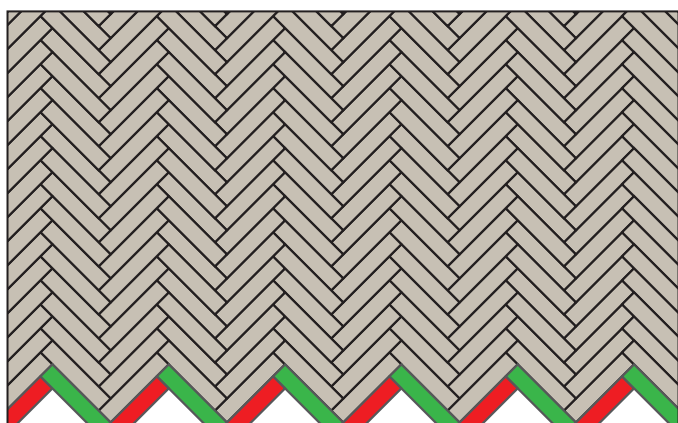

15 Continue laying the entire space in this manner. After 30 minutes from installation, the floor can be lightly loaded. This allows kneeling on the floor to install other PVC Dryback parts.

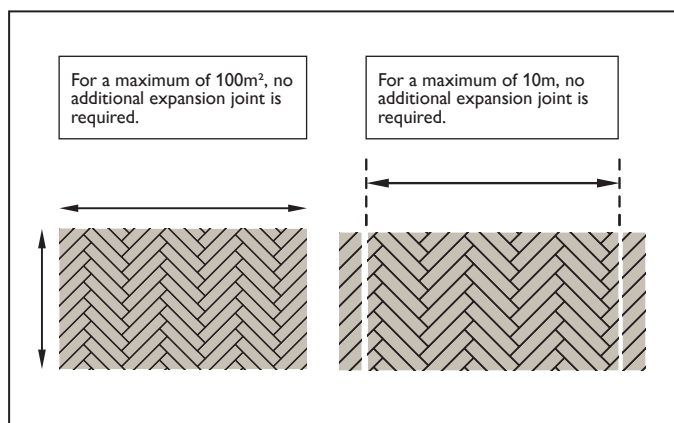

16 The maximum area to be installed is 100m<sup>2</sup>. The maximum length of the floor surface that can be laid in one direction is 10m. For an area larger than 100m<sup>2</sup> or a length greater than 10m, an additional expansion joint is required. Additionally, all expansion joints along the walls must be increased by 5mm.

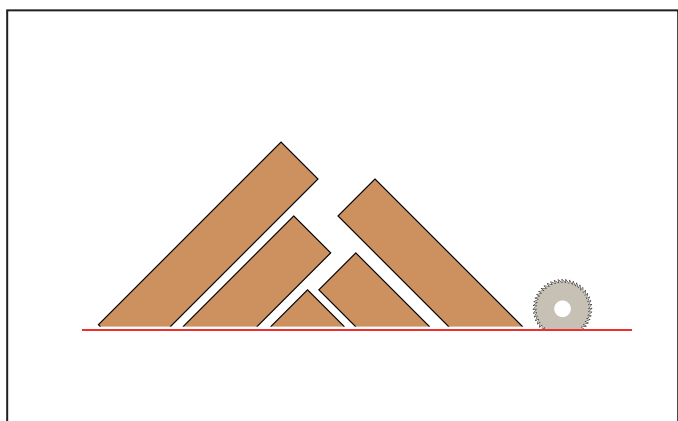

17 When we reach the last strip, the cut floorboards from the first row (step 3) come in handy again. The remnants of the first row's triangles can be used to fill in the remaining gaps and complete the floor.

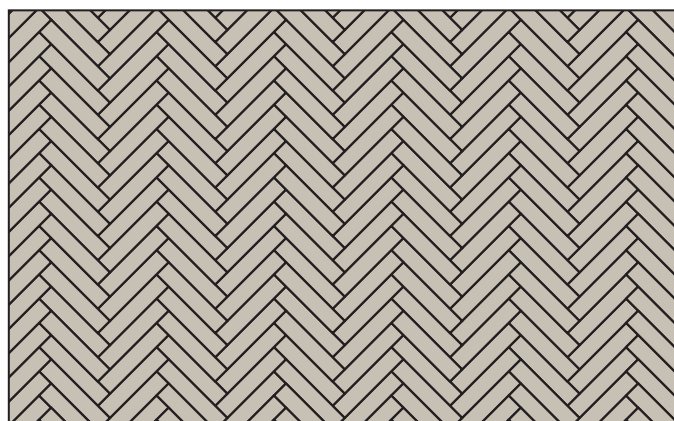

18 The adhesive will fully cure after 24 hours. Until then, it is not recommended to place furniture or other heavy objects on the floor or to clean it.

## SPECIAL FEATURES AND FINISHING

---

### Humid areas

In damp environments, we recommend sealing the floor at connections to walls and sanitary fixtures with polyurethane sealant. Please note that this floor cannot be used as a shower floor.

### Finishing

Finish the edges with a neat baseboard. After installation with the self-adhesive underlay, the floor can be walked on and loaded after 24 hours. The same applies to installation with PVC adhesive. If a different adhesive has been used, please follow the instructions provided for that adhesive.

## MAINTENANCE

---

Just like everything you use on a daily basis, a floor you live on also needs maintenance. Fortunately, Solidfloor Dryback is very easy to maintain, making it simple to keep clean. Solidfloor has developed 2 different products specifically for its floors.

### Easy Clean

When it's time for a thorough cleaning and you want to give your floor an intensive cleanse, use Solidfloor Easy Clean. Always read the instructions before use.

### Easy Protect

After an intensive cleaning, use Solidfloor Easy Protect to give your floor a durable protective layer, so it can withstand wear and tear for a longer period.

## TERMS AND CONDITIONS

---

### Preventive Tips

Prolonged exposure to direct sunlight can damage your floor. Use curtains to minimize direct sunlight. Use a good doormat to prevent moisture and dirt from being tracked inside. Avoid rubber floor mats and black furniture caps. Use high-quality felt pads on chair legs and other furniture to protect the floor, and avoid dragging heavy objects across the floor. If using furniture with wheels, ensure that the wheels are suitable for a flat vinyl flooring surface (no rubber). Placing a floor mat under office chairs is recommended to prevent damage.

## WARRANTY TERMS AND CONDITIONS

---

This floor has been produced with care. In the event of hidden material and/or production defects occurring within the specified period after the date of purchase, the following warranty conditions apply:

- If you notice visible defects in the product after opening the packaging, you must report this to your point of purchase before installation.
- Defects cannot exceed the value of the delivered material. Parts with visible defects should not be installed. Damages will be considered with economic depreciation taken into account. The residual value will be determined based on the remaining warranty period of your floor.
- Warranty claims can only be made with the presentation of the invoice or purchase receipt.
- You can find the complete warranty conditions of Solidfloor on the website.

*If you have any questions, please contact your point of purchase.*

### Warranty voids:

- Damages due to wear, damages, and tears on the wear surface caused by improper use, falling objects, sand ingress, and/or usage of sharp tools.
- Rough and/or improper use.
- Any other careless use of the product.
- If a defect in the product could already be determined before installation.
- Usage of the material or application in unsuitable spaces.
- Installation on unsuitable subfloors or climatic conditions other than specified in these installation instructions.

These warranty conditions do not affect your statutory rights and obligations. Usage class 23/33 (intensive residential use and intensive commercial use).



**Solidfloor**

Abram Dudok van Heelstraat 4  
1096BE Amsterdam  
[www.solidfloor.com](http://www.solidfloor.com)

 [www.facebook.com/solidfloor.nl](https://www.facebook.com/solidfloor.nl)

 [www.pinterest.com/floortjesol](https://www.pinterest.com/floortjesol)

 [www.instagram.com/solid.floor](https://www.instagram.com/solid.floor)

